



POWER DUO IMMERSION BLENDER + WHISK CI200 Series | Owner's Guide

IMPORTANT SAFETY INSTRUCTIONS

PLEASE READ ALL INSTRUCTIONS BEFORE USE • FOR HOUSEHOLD USE ONLY

	Read and review instructions for operation and use.
	Indicates the presence of a hazard that can cause personal injury, death, or substantial property damage if the warning included with this symbol is ignored.
	For indoor and household use only.
When using electrical appliances, basic safety precautions should always be followed, including the following:	

⚠WARNING: To reduce the risk of injury, fire, electrical shock or property damage, basic safety precautions must always be followed, including the following numbered warnings and subsequent instructions. Do not use appliance for other than intended use.

⚠WARNING: DO NOT blend hot liquids in the 3-cup blending vessel, 4-cup blending pitcher, or sealed vessels. Doing so may result in pressure buildup and release of hot contents that can pose a risk of serious burns.

⚠WARNING: To blend hot liquids, use only the immersion blender attachment with an unsealed vessel (such as the metal sauce pan used to heat the ingredients) and wait for the ingredients to cool slightly before blending. Failure to do so can pose a risk of serious burns.

- 1 Read all instructions prior to using the appliance and its accessories.
- 2 Carefully observe and follow all warnings and instructions. This unit contains electrical connections and moving parts that potentially present risk to the user.
- 3 **ALWAYS** exercise care when handling the immersion blender attachment. The blades are sharp; handle carefully. **ONLY** grasp the immersion blender attachment by the upper bell or shaft. Failure to use care when handling the immersion blender attachment will result in a risk of laceration.
- 4 Immersion blender blades are sharp. Handle carefully.
- 5 Before each use, inspect blades for damage. If a blade is bent or damage is suspected, contact SharkNinja to arrange for replacement.
- 6 **DO NOT** attempt to sharpen blades.
- 7 Take your time and exercise care during unpacking and appliance setup. This appliance contains sharp blades that can cause injury if mishandled.
- 8 Take inventory of all contents to ensure you have all parts needed to properly and safely operate your appliance.
- 9 Unplug the appliance from the outlet when not in use, before assembling or disassembling parts, and before cleaning. To unplug, grasp the plug by the body and pull from the outlet. **NEVER** unplug by grasping and pulling the flexible cord.
- 10 Before use, wash all parts that may contact food. Follow washing instructions covered in this instruction manual.
- 11 To protect against the risk of electric shock, **DO NOT** submerge the PowerBase™. **DO NOT** allow the power cord to contact any form of liquid. Unplug the PowerBase before cleaning.
- 12 Remove the whisk from the RapidWhisk attachment before washing.
- 13 **DO NOT** use this appliance outdoors. It is designed for indoor household use only.

IMPORTANT SAFETY INSTRUCTIONS

PLEASE READ ALL INSTRUCTIONS BEFORE USE • FOR HOUSEHOLD USE ONLY

- 14 This appliance has important markings on the plug. The attachment plug or entire cordset (if plug is molded onto cord) is not suitable for replacement. If damaged, the appliance shall be replaced.
- 15 This appliance has a polarized plug (one prong is wider than the other). To reduce the risk of electric shock, this plug will fit in a polarized outlet only one way. If the plug does not fit fully in the outlet, reverse the plug. If it still does not fit, contact a qualified electrician. **DO NOT** modify the plug in any way.
- 16 **DO NOT** operate any appliance with a damaged cord or plug, or after the appliance malfunctions or is dropped or damaged in any manner. This appliance has no user-serviceable parts. If damaged, contact SharkNinja for servicing.
- 17 Extension cords should **NOT** be used with this appliance.
- 18 **DO NOT** allow children to operate this appliance or use as a toy. Close supervision is necessary when any appliance is used near children.
- 19 This appliance is **NOT** intended to be used by people with reduced physical, sensory, or mental capabilities, or lack of experience and knowledge, unless they have been given supervision or instruction concerning use of the appliance by a person responsible for their safety.
- 20 Fully unwind the power cord before use. **DO NOT** allow the unit or the cord to hang over the edges of tables or counters. The cord may become snagged and pull the appliance off the work surface.
- 21 **DO NOT** allow any part of the unit to contact hot surfaces, including stoves and other heating appliances.
- 22 **ALWAYS** use the appliance on a dry and level surface.
- 23 Keep hands, hair, and clothing out of the container when loading and operating.
- 24 **ONLY** use attachments and accessories that are provided with the product or are recommended by SharkNinja. The use of attachments not recommended or sold by SharkNinja may cause fire, electric shock, or injury.
- 25 During operation and handling of the appliance, avoid contact with moving parts.
- 26 **DO NOT** operate the appliance with an empty container.
- 27 **DO NOT** fill containers past the MAX FILL or MAX LIQUID lines.
- 28 **DO NOT** microwave any containers or accessories provided with the appliance.
- 29 **DO NOT** perform grinding operations.
- 30 Before operation, ensure all utensils are removed from containers. Failure to remove utensils can cause containers to shatter and potentially result in personal injury and property damage.
- 31 **DO NOT** expose the containers and accessories to extreme temperature changes. They may experience damage.
- 32 **NEVER** leave the appliance unattended while in use.
- 33 **DO NOT** blend hot liquids in the 3-cup blending vessel, 4-cup blending pitcher, or sealed vessels. Doing so may result in pressure buildup and release of hot contents that can pose a risk of serious burns.
- 34 **DO NOT** process dry ingredients without adding liquid to the immersion blender. They are not intended for dry blending.
- 35 Keep hands and utensils out of containers while processing to reduce the risk of severe personal injury or damage to the unit. A scraper may be used **ONLY** when the unit is not running.
- 36 Immediately release the power button on the power base in the event that the appliance malfunctions during of the immersion blender.
- 37 Make sure the PowerBase™ is securely attached to the RapidWhisk attachment or immersion blender attachment.
- 38 Always ensure the whisk is fitted securely in the RapidWhisk attachment before processing.
- 39 **DO NOT** use containers if they are cracked or chipped.
- 40 To avoid contact with steam and hot surfaces, **DO NOT** reach across top of vessel in which you are processing.

- 41 If the appliance overheats, a thermal switch will activate and temporarily disable the motor. To reset, unplug the appliance and allow it to cool for approximately 15 minutes before using again.
- 42 To blend hot liquids, use only the immersion blender attachment with an unsealed vessel (such as the metal sauce pan used to heat the ingredients) and wait for the ingredients to cool slightly before blending. Failure to do so can pose a risk of serious burns.
- 43 When blending in a cooking pot on a stovetop, remove the pan from the heating element or ensure the heating element is turned OFF prior to blending to reduce the risk of burns.
- 44 **DO NOT** use any other accessories in the RapidWhisk Adapter except the included whisk.

SAVE THESE INSTRUCTIONS

PARTS

NOTE: Attachments and accessories, as well as color of unit, vary by model.

- A PowerBase™
(attached power cord not shown)
- B Immersion Blender Attachment
- C RapidWhisk Adapter
- D RapidWhisk Attachment
- E 3-Cup Blending Vessel

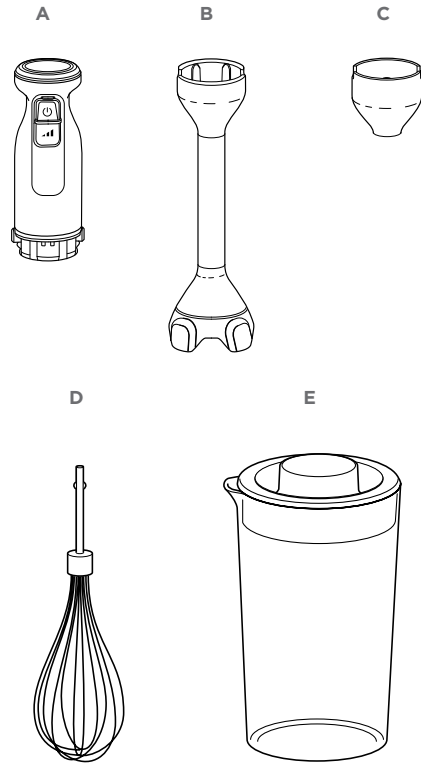

To purchase more accessories and find great recipes, visit ninjakitchen.com.

BEFORE FIRST USE

IMPORTANT: Review all warnings before proceeding.

NOTE: Attachments and accessories vary by model

- 1 Remove all packaging materials from the unit. Exercise care when unpacking the immersion blender attachment.
- 2 Wash immersion blender attachment, RapidWhisk attachment, and blending vessel in warm, soapy water. Use a dishwashing utensil with a handle to avoid direct contact with the blades on the immersion blender attachment. Exercise care when handling the blade, as it is sharp. Thoroughly rinse and air-dry all parts.
- 3 Wipe the PowerBase™ with a clean, damp cloth.

USING THE CONTROL PANEL

IMMERSION BLENDER

- 1 **POWER**
Press  and **hold continuously** to blend. The unit will not blend unless the power button is pressed down.
- 2 **VARIABLE SPEEDS**
While continuously holding the power button, press the VARIABLE SPEED button to ramp up to higher speeds. By default, the unit will start on low speed. While plugged in but not in use, there will be a 30 second memory for the latest speed, and then unit will default back to low speed.



RAPIDWHISK ATTACHMENT ASSEMBLY

IMPORTANT: Review all warnings before proceeding

- 1 Install RapidWhisk Attachment in adapter by aligning it with the slots on the adapter. You will feel the RapidWhisk Attachment click into place when it's correctly installed.

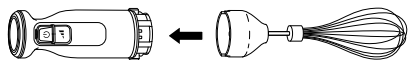
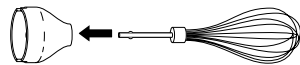

- 2 Attach the RapidWhisk Attachment Assembly to the PowerBase™ by aligning the arrows then pushing the assembly onto the PowerBase.

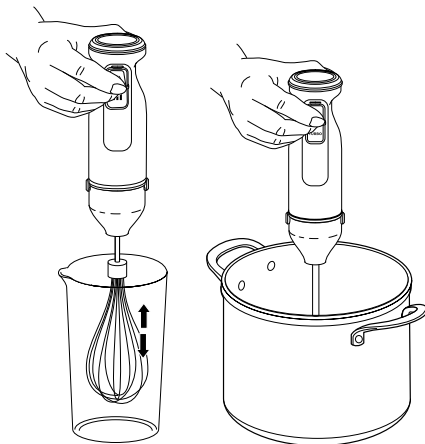

- 3 Plug the unit in, the unit will begin mixing on speed 1. Use the speed selector to increase speed. For best results, use lower speeds for combining dry ingredients, and higher speeds for whipping cream or egg whites.

NOTE: For larger containers, whisk in a circular or side-to-side motion for even mixing.

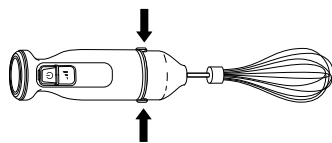

- 4 To remove the RapidWhisk Attachment Assembly from the PowerBase, first unplug the unit. Then press and hold the release buttons on both sides of the PowerBase while you pull the assembly out of the PowerBase.

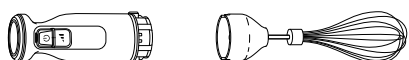

- 5 Refer to the Care & Maintenance section for cleaning and storage instructions.

IMMERSION BLENDER ATTACHMENT ASSEMBLY

IMPORTANT: Review all warnings before proceeding

NOTE: When blending in a cooking pot on a stovetop, remove the pan from the heating element or ensure the heating element is turned OFF prior to blending to reduce the risk of burns.

- 1 Install the immersion blender attachment to the PowerBase™ by aligning the arrow on the PowerBase with the arrow on the immersion blender attachment. Then, push the attachment onto the PowerBase to lock in place. Plug the unit in.

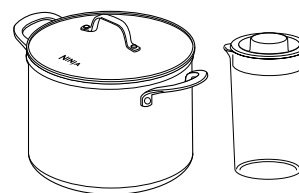
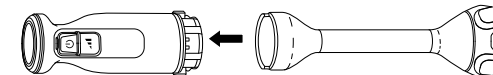

- 2 Prior to blending, make sure to use a container large enough to fully submerge the blender head in ingredients. Once submerged, there should be ample room in the container to avoid overflowing and splashing. A cooking pot, large measuring container, or the blending vessel (not available with all models) is recommended.

- 3 Submerge blender head in the ingredients. Press and **hold** the while using an up-and-down motion to blend, making sure to stop blending anytime head is no longer submerged. While continuously holding to blend, press the VARIABLE SPEED button to ramp up to high speed.

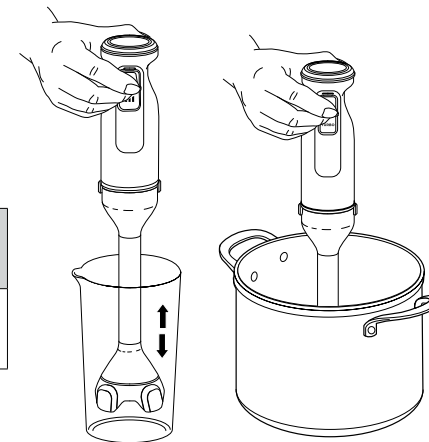

LOW SPEEDS	Use to blend liquids, such as mayo or dressing, or soups and sauces with soft ingredients, such as tomato sauce.
HIGH SPEEDS	Use for tougher ingredients, such as butternut squash, or for smooth purees, such as hummus.

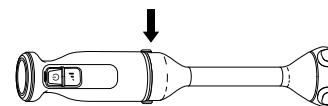

- 4 To remove the immersion blender attachment from the PowerBase, first unplug the unit. Then press and hold the release buttons on both sides of the PowerBase while you pull the attachment out of the PowerBase.



- 5 Refer to the Care & Maintenance section for cleaning and storage instructions.

CARE & MAINTENANCE

⚠WARNING: Handle the chopper blade with care when washing, as the blades are sharp. Contact with the blade's edges can result in laceration.

CLEANING

• Hand-Washing

Wash the immersion blender attachment, whisk, and blending vessel in warm, soapy water. Use a dishwashing utensil with a handle to avoid direct contact with the blades on the immersion blender attachment. Exercise care when handling blade assemblies, as blades are sharp. Thoroughly rinse and air-dry all parts.

• Dishwasher

All attachments, with the exception of the PowerBase™, are dishwasher safe..

• PowerBase

Unplug the PowerBase before cleaning. Wipe the PowerBase with a clean, damp cloth. Do not submerge this part in water.

STORING

For cord storage, wrap the cord with the plastic clip.

RESETTING THE MOTOR

This unit features a unique safety system that prevents damage to the motor and drive system should you inadvertently overload it. If the unit is overloaded, the motor will be temporarily disabled. Should this occur, follow the reset procedure below.

- 1 Unplug the unit from the electrical outlet.
- 2 Allow the unit to cool for approximately 15 minutes.
- 3 Remove the attachment. Make sure no ingredients are jamming the accessory.

IMPORTANT: Ensure that maximum capacities are not exceeded. This is the most typical cause of appliance overload.

If your unit needs servicing, please call Customer Service at 1-877-646-5288. So we may better assist you, please register your product online at registryourninja.com and have the product on hand when you call.

ORDERING REPLACEMENT PARTS & ACCESSORIES

To order additional parts and attachments, visit ninjaaccessories.com.

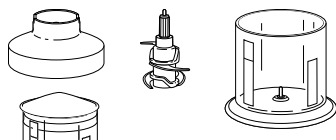

Ninja® Power Chopper

The Power Chopper Attachment includes a 3-cup chopper, stacked blade assembly, processing lid, and storage lid.

TROUBLESHOOTING GUIDE

⚠WARNING: To reduce the risk of shock and unintended operation, turn power off and unplug unit before troubleshooting.

Unit doesn't turn on.

- Ensure the unit is plugged into a working outlet.
- Make sure to fully lock an attachment onto the PowerBase™. Align the arrow on the PowerBase with the arrow on the desired attachment. Then push the PowerBase onto the attachment to lock in place.
- Check that the bottom of PowerBase is clean and there is no food blocking connection when installing attachments.

Immersion blender will run only momentarily.

- Press and hold the  to blend. Holding the power button continuously to blend ensures that the blade only runs when you're in control.

Immersion blender is spraying ingredients.

- We recommend using a cooking pot, a large glass measuring container or the included blending vessel (not included with all models) to blend ingredients.
- The container should be large enough for the blender head to be fully submerged in the ingredients, along with ample room in the container to avoid overflowing and splashing.
- Submerge the blender head in the ingredients. Move the immersion bell in an up-and-down motion through the ingredients to blend, making sure to stop blending anytime the blender head is not submerged.

Food is stuck in immersion blender blade.

- Power the unit off and unplug the PowerBase. Use a spatula or other kitchen utensil to dislodge the food. Handle the immersion blender attachment with care and do not attempt to dislodge food using your hand.

Cannot remove attachments.

- Be sure to press the release buttons on the side of the PowerBase to remove attachments.

The unit stopped blending or mixing.

- Do not run the unit more than 10 minutes continuously. Unplug the unit from the electrical outlet and allow it to cool for 15 minutes.

ONE (1) YEAR LIMITED WARRANTY

NJA_1_YR_IB_LMTD_WRNTY_US_ENG

The One (1) Year Limited Warranty applies to purchases made from authorized retailers of **SharkNinja Operating LLC**. Warranty coverage applies to the original owner and to the original product only and is not transferable.

SharkNinja warrants that the unit shall be free from defects in material and workmanship for a period of one (1) year from the date of purchase when it is used under normal household conditions and maintained according to the requirements outlined in the Owner's Guide, subject to the following conditions and exclusions:

What is covered by this warranty?

1. The original unit and/or non-wearable parts deemed defective, in SharkNinja's sole discretion, will be repaired or replaced up to one (1) year from the original purchase date.
2. In the event a replacement unit is issued, the warranty coverage ends six (6) months following the receipt date of the replacement unit or the remainder of the existing warranty, whichever is later. SharkNinja reserves the right to replace the unit with one of equal or greater value.
California Residents Only: The One (1) Year Limited Warranty period begins on the original date of delivery or pickup.

What is not covered by this warranty?

1. Normal wear and tear of wearable parts (such as blending vessels, lids, cups, blades, blender bases, removable pots, racks, pans, etc.), which require regular maintenance and/or replacement to ensure the proper functioning of your unit, are not covered by this warranty. Replacement parts are available for purchase at ninjaaccessories.com.
2. Any unit that has been tampered with or used for commercial purposes.
3. Damage caused by misuse, abuse, negligent handling, failure to perform required maintenance (e.g., failure to keep the well of the motor base clear of food spills and other debris), or damage due to mishandling in transit.
4. Consequential and incidental damages.
5. Defects caused by repair persons not authorized by SharkNinja. These defects include damages caused in the process of shipping, altering, or repairing the SharkNinja product (or any of its parts) when the repair is performed by a repair person not authorized by SharkNinja.
6. Products purchased, used, or operated outside North America.

How to get service

If your appliance fails to operate properly while in use under normal household conditions within the warranty period, visit ninjakitchen.com/support for product care and maintenance self-help. Our Customer Service Specialists are also available at **1-877-646-5288** to assist with product support and warranty service options, including the possibility of upgrading to our VIP warranty service options for select product categories. So we may better assist you, please register your product online at registeryourninja.com and have the product on hand when you call.

SharkNinja will cover the cost for the customer to send in the unit to us for repair or replacement. A fee of \$20.95 (subject to change) will be charged when SharkNinja ships the repaired or replacement unit.

How to initiate a warranty claim

You must call **1-877-646-5288** to initiate a warranty claim. You will need the receipt as proof of purchase. We also ask that you register your product online at registeryourninja.com and have the product on hand when you call, so we may better assist you. A Customer Service Specialist will provide you with return and packing instruction information.

How state law applies

This warranty gives you specific legal rights, and you also may have other rights that vary from state to state. Some states do not permit the exclusion or limitation of incidental or consequential damages, so the above may not apply to you.



REGISTER YOUR PURCHASE



registeryourninja.com



Scan QR code using mobile device

RECORD THIS INFORMATION

Model Number: _____

Serial Number: _____

Date of Purchase: _____
(Keep receipt)

Store of Purchase: _____

TECHNICAL SPECIFICATIONS

Voltage: 120V-, 60Hz

Power: 6A

SharkNinja Operating LLC

US: Needham, MA 02494

1-877-646-5288

ninjakitchen.com

Illustrations may differ from actual product. We are constantly striving to improve our products; therefore the specifications contained herein are subject to change without notice.

NINJA is a registered trademark of SharkNinja Operating LLC.

POWERBASE is a trademark of SharkNinja Operating LLC.

This product may be covered by one or more U.S. patents.
See sharkninja.com/patents for more information.

© 2025 SharkNinja Operating LLC.

CI200Series_IB_MP_Mv2



@ninjakitchen